

The ShockLog Satellite Impact and Tracking recorder combines the powerful impact and environmental recording capabilities of the ShockLog 298 Impact Recorder with a satellite location/tracking module to deliver outstanding impact recording, real-time impact reporting and asset location around the globe.

ACTIVATING THE SHOCKLOG SATELLITE

PLEASE NOTE: Activation of the satellite module can take up to 2 business days. Please plan accordingly.

If this is the first connected device purchase for your company, you must establish an account admin. This person will be responsible for managing user access to the SpotSee Cloud.

- Navigate to activate.spotsee.io to begin the activation process.
 - Enter the Customer Number found on the packing list that shipped with the ShockLog Cellular, the SpotSee invoice or order acknowledgement.
 - Enter the Unit ID found on the label on the ShockLog Satellite.
 - Accept the Terms and Conditions.
 - Click Activate.
- Enter the admin email address in the pop-up box and click Enter
- An email will be sent to the ADMIN's email address from no-reply@shockwatch.com.

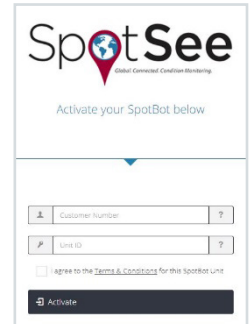

NOTE: If the email is not received within 5 minutes, please check your spam or junk folders. If it has still not been received, please contact SpotSee technical support.

- Follow the link in the email to create your password.

- A message will prompt you to select an available contract for the unit. Click the dropdown list to select a contract.
- Click Activate.

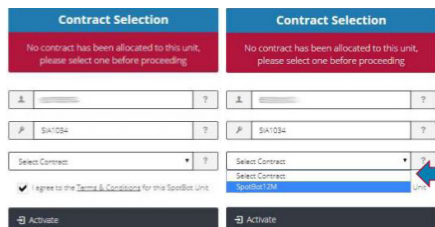

The ShockLog Satellite activation process has started. Please allow up to two business days for the communication module to become active.

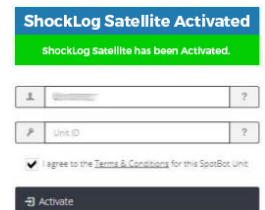

PROGRAMMING THE SHOCKLOG SATELLITE

The ShockLog 298 recorder must be programmed prior to use. For complete details on programming the device, please refer to the ShockLog Satellite User Manual. The manual can be located on the ShockLog software installation USB.

When programming the ShockLog 298 Impact Recorder, it is important to set a summary interval such that the memory and batteries will last for the anticipated journey time. Consult the table below for determining the best summary interval and for setting up appropriate battery replacement intervals.

Summary Interval	ShockLog Memory Full*	ShockLog Satellite Module Internal Battery Life	ShockLog Satellite Module External Battery Life	Interface Board Battery	ShockLog Battery
1 hour	42 days	3 months	60 days	12 months	12 months
2 hours	85 days	3 months	60 days	12 months	12 months
4 hours	5.5 months (170 days)	6 months	75 days	12 months	12 months
8 hours	11 months (341 days)	12 months	90 days	12 months	12 months
12 hours	16 months (512 days)	18 months	90 days	12 months	12 months

*When the ShockLog memory is full, only alarms will be reported not summaries.

POWERING THE SHOCKLOG SATELLITE

All required lithium batteries for the ShockLog and ShockLog Satellite module are installed at the factory unless otherwise arranged with SpotSee. (Figure 1)

CAUTION - RISK OF EXPLOSION IF BATTERY IS REPLACED BY AN INCORRECT TYPE. DISPOSE OF USED BATTERIES ACCORDING TO THE INSTRUCTIONS.

Note: Operating the ShockLog Satellite in a location without line of sight to the sky will significantly reduce the battery life of the satellite module.

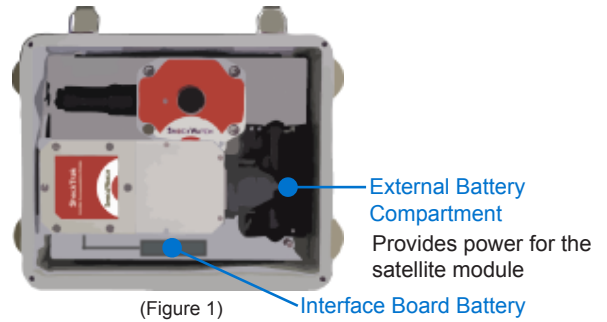

(Figure 1)

Component	Battery Type	Qty
ShockLog	3.6V AA Lithium Batteries	2
Interface Board Battery	3.6V AA Lithium Battery	1
ShockLog Satellite Module (Internal)	1.5V AA Lithium Batteries	4
ShockLog Satellite Module (External)	3.6V C Lithium Batteries	4

CONNECTING THE SHOCKLOG SATELLITE MODULE AND SHOCKLOG RECORDER

The ShockLog Satellite module and the ShockLog must be connected prior to use. A plug on the satellite module covers the communication port between the module and the ShockLog.

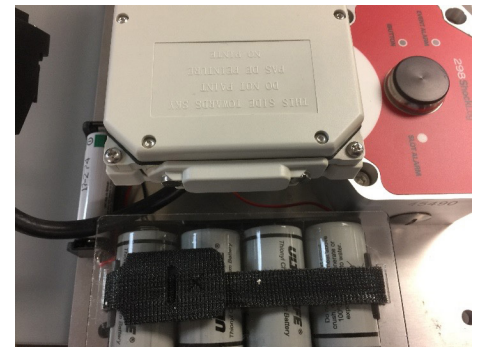
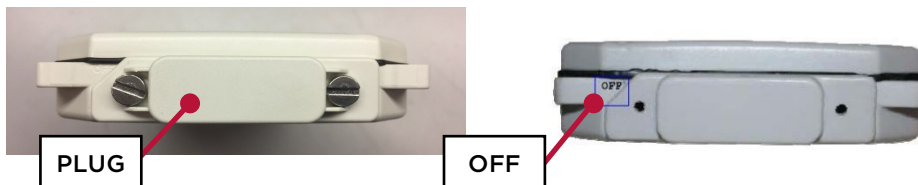

- Prior to use, the module will show “OFF” on the end of the module.
- Unscrew the plug and remove.
- Connect the black connector / cable to the communication port of the satellite module.
- Keep the plug in a safe place as it will be used to turn the device off when not in use.

SENDING A TEST MESSAGE (OPTIONAL)

- If you would like to send a test message to ensure that the unit has been set up correctly, start the ShockLog (See Starting the ShockLog)
- With line of site to the sky, drop the ShockLog Satellite approximately 6 inches to generate an impact.
- Verify that the impact message was delivered to the SpotSee Cloud.

MOUNTING THE SHOCKLOG SATELLITE

It is recommended that you mount the unit prior to starting it. This prevents any impacts being recorded during the mounting process.

- Find suitable mounting location on asset with line of sight to the sky.
- The ShockLog Satellite has x, y, and z axes noted on the unit. If the mounting of the ShockLog Satellite does not allow you to match the axes of the unit, it is advisable to make note of the exact mounting in order to correctly analyze the reported impact values.
- To adhere, position two magnets in place and then carefully roll the last two magnets into position. (Figure 2)

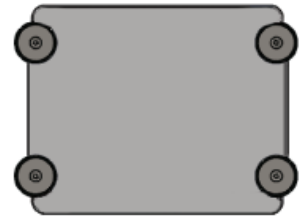

(Figure 2)

Note: Magnetic mounts are intended for temporary mounting.

STARTING THE SHOCKLOG SATELLITE

It is recommended that the START iButton be used to start the ShockLog recorder. (Figure 3). The iButton can be stored in the ShockLog Satellite case to allow the unit to be started once mounted.



(Figure 3)

- Remove black center cap from ShockLog iButton port. (Figure 4)
- Insert START iButton into iButton port.
 - When iButton LED on ShockLog is red (Figure 4) and Slot Alarm LED is green (Figure 4), remove iButton.
 - Unit will start after one (1) minute
- Close lid and secure latches. (Figure 5)



(Figure 4)

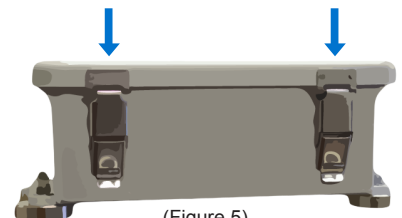

(Figure 5)

ACCESSING THE CLOUD

Navigate to <https://cloud.spotsee.io> to view the impact and location information. On the Dashboard, select the asset of interest by clicking on the asset name.

A map showing the asset location as well as a list of impacts over time and an impact histogram will appear. When an over threshold event occurs during the journey, an alert will be sent through the web-hosted application and the ShockLog LED Event Alarm will flash red every five (5) seconds for an alarm condition and every ten (10) seconds for a warning condition.

For a complete description of the SpotSee Cloud, please refer to the ShockLog Satellite User Manual.

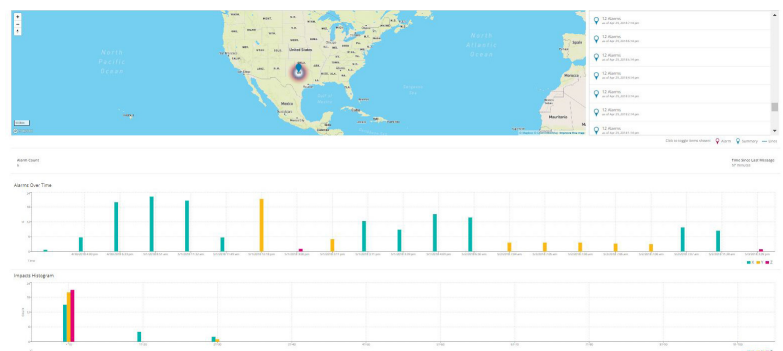
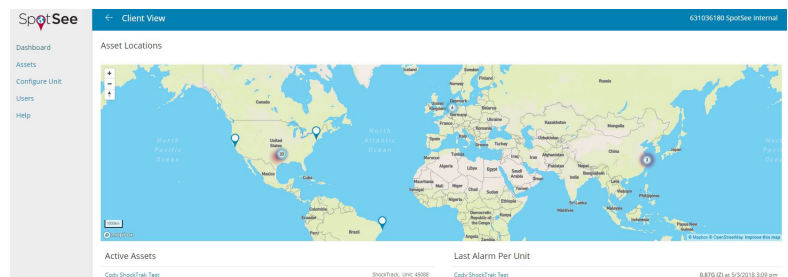

DOWNLOADING THE FULL REPORT

It is possible to use the ShockLog 298 software to analyze any impact events that occur during the trip. To download and analyze the complete data file, please refer to the ShockLog Satellite User Manual.

RECOMMENDED STORAGE

When the unit is not in use, it is recommended that the ShockLog be stopped and the satellite module be turned off.

To turn the satellite module off, locate the satellite module in the ShockLog Satellite box and disconnect the connector / cable.

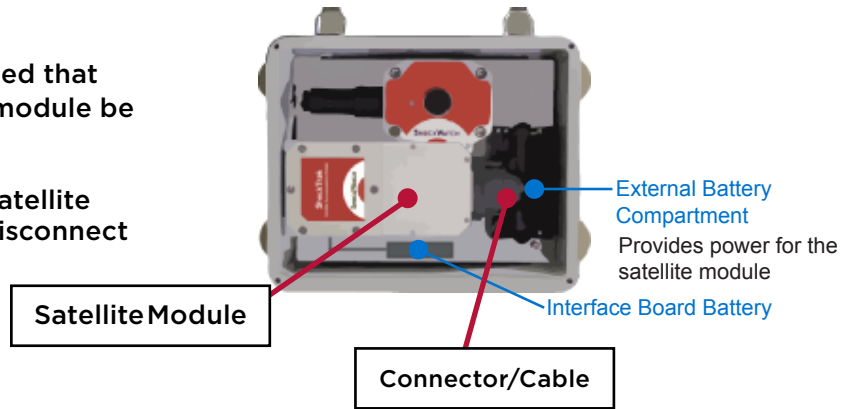

Locate the plug and insert it into the connector such that the word OFF is visible. Note: If the word ON is visible, you will be powering the module and draining the battery.



SAFETY WARNING



MAGNETIC FIELDS PRESENT

The mounting plate described in these instructions has a magnetic field. Do not locate near pacemakers or other equipment that is sensitive to magnets.

PINCH HAZARD

Mounting ShockLog Satellite may cause injury to hands. Exercise caution to avoid pinching hands and fingers when installing the mounting unit.

FOR QUESTIONS OR TROUBLE SHOOTING PLEASE CONTACT TECHNICAL SUPPORT

Email: techsupport@spotsee.io

SpotSee Canada & Americas:

US: +1 800-466-0101 Outside US: +1 214-736-4579

SpotSee Europe, Middle East, Africa: +31.55.7370 148

SspotSee Asia-Pacific: +86 (21) 6627 6008